



1767

Additional Instructions

Seam middle guide

IMPORTANT
READ CAREFULLY BEFORE USE
KEEP FOR FUTURE REFERENCE

All rights reserved.

Property of Dürkopp Adler AG and protected by copyright. Any reuse of these contents, including extracts, is prohibited without the prior written approval of Dürkopp Adler AG.

Copyright © Dürkopp Adler AG 2017

1	General information	3
2	Assembling the seam middle guide.....	5
2.1	Assembling the mechanical seam middle guide.....	5
2.2	Assembling the pneumatic seam middle guide	7
3	Setting the seam middle guide in the software	12
3.1	Assigning the <i>pneumatic seam middle guide</i> function to a free button	12
3.2	Assigning <i>seam middle guide</i> function to the <i>Bartack</i> button.....	13
4	Setting operating pressure of the pneumatic seam middle guide	15

1 General information

The seam middle guide is used as an aid to guide the material during top stitching.

The seam middle guide shows the midway point between 2 seams so that the distance is the same from the middle to the left and right needle.

These kits can be assembled on all 2-needle machines of class 1767.

The seam middle guide is available in several versions:

- Mechanical seam middle guide (kit N800 005655)
- Pneumatic seam middle guide integrated into the presser foot (sewing equipment E24/.../... mm stitch length)

Components of the kit N800 005655

Check whether the scope of delivery for the kit is correct prior to installation.

Part number	Quantity	Description
0667 245004	1	Stop V
9202 002077	2	Cheese-head screw (M4x10)
9202 002877	2	Cheese-head screw (M6x10)
9330 000087	2	Washer (A4, 3)
N800 075013	1	Ruler, K
N800 080003	1	Holder

Fig. 1: General information; mechanical seam middle guide

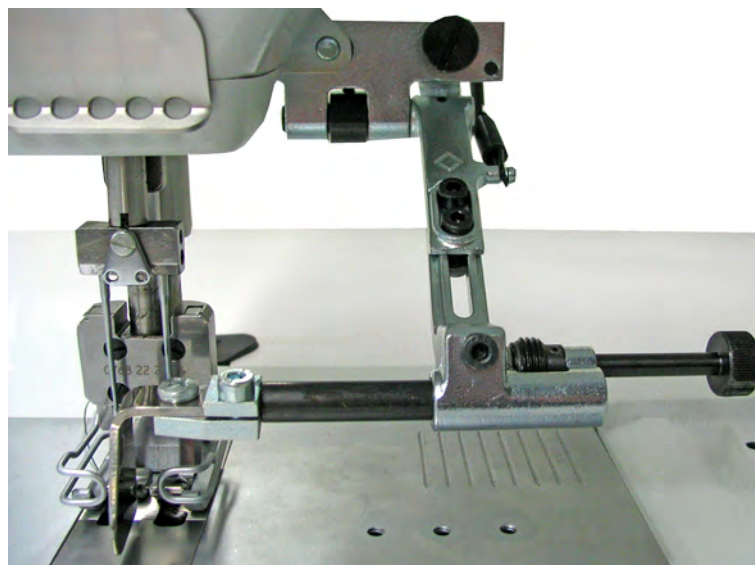

Pneumatic seam middle guide

The pneumatic seam middle guide is integrated into the presser foot (sewing equipment E24/.../... mm stitch length).

Fig. 2: General information: pneumatic seam middle guide in presser foot



2 Assembling the seam middle guide

2.1 Assembling the mechanical seam middle guide

Fig. 3: Assembling the mechanical seam middle guide (1)

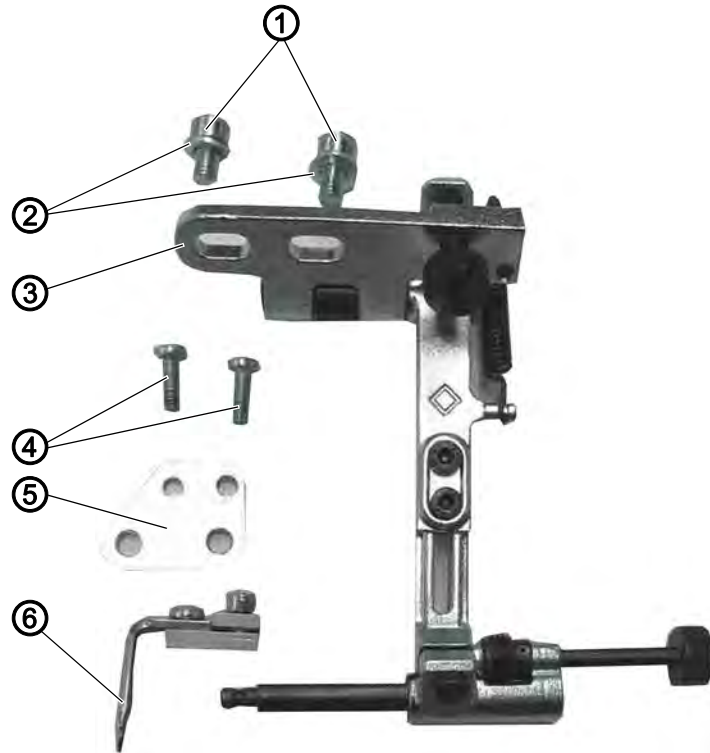

- | | |
|-------------------------------|-------------------------|
| (1) - Screw | (4) - Screw |
| (2) - Washer | (5) - Plate |
| (3) - Bracket (pre-assembled) | (6) - Seam middle guide |

Fig. 4: Assembling the mechanical seam middle guide (2)

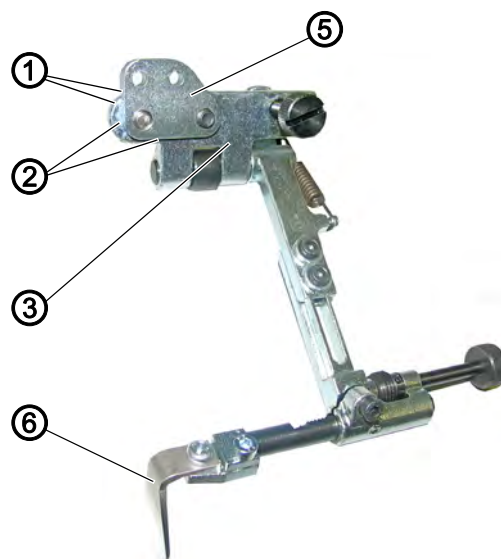

- | | |
|---------------------------|-------------------------|
| (1) - Screw (not visible) | (5) - Plate |
| (2) - Washer | (6) - Seam middle guide |
| (3) - Bracket | |



To assemble mechanical seam middle guide:

1. Screw the plate (5) to the bracket (3) using the screws (1) and the washers (2).
2. Screw the seam middle guide (6) to the bracket (3).
3. Screw the plate (5) from the rear to the sewing head using the screws (4).

Fig. 5: Assembling the mechanical seam middle guide (3)

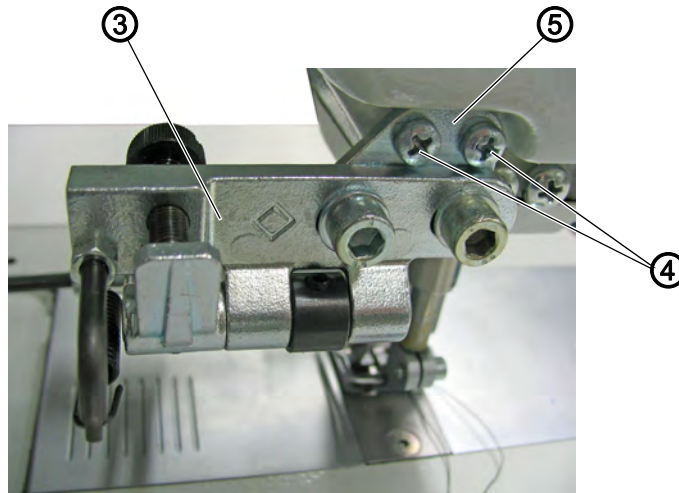

(3) - Bracket
(4) - Screw

(5) - Plate



4. Align the bracket (3) horizontally to the tabletop.
Make sure that the distance to the left and right needle is the same. There should be a distance of 1 mm between the seam middle guide (6) and the throat plate.

Fig. 6: Assembling the mechanical seam middle guide (4)

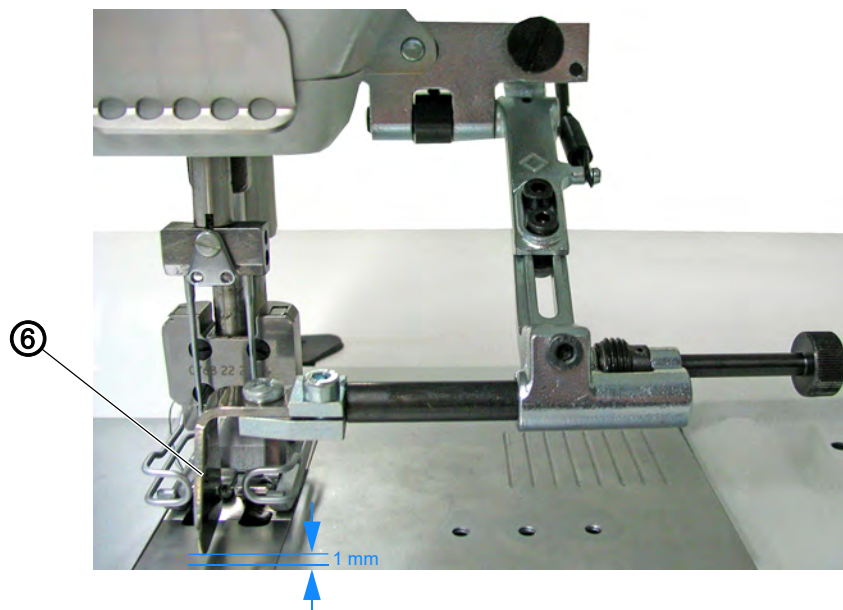

(6) - Seam middle guide

2.2 Assembling the pneumatic seam middle guide

DANGER



Risk of death from live components!

Unprotected contact with electricity can result in serious injuries or death.

Only qualified specialists may perform work on electrical equipment.

Switch off the machine and disconnect the power plug before assembling the pneumatic seam middle guide.

NOTICE

Property damage may occur!

Damage to the sewing material or individual parts of the seam middle guide.

Set a maximum of 3 bar for the seam middle guide on the pressure gage of the compressed air unit.

NOTICE

Property damage may occur!

The pneumatic hose can be damaged by kinking or crushing.

Do NOT kink or crush the pneumatic hose.

Fig. 7: Assembling the pneumatic seam middle guide (1)

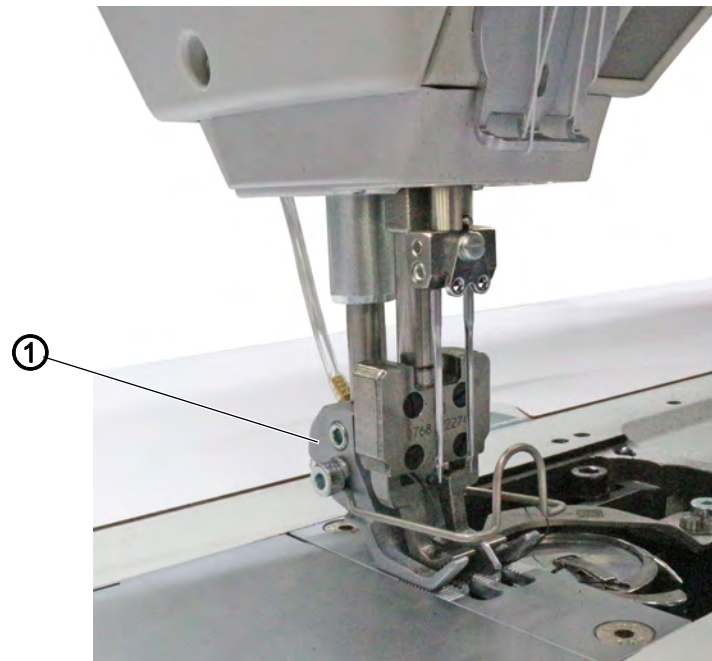

(1) - Sewing feet



To assemble the pneumatic seam middle guide:

1. Remove the rear cover.
2. Disassemble the old sewing feet.
3. Assemble the new sewing feet (1).

Fig. 8: Assembling the pneumatic seam middle guide (2)

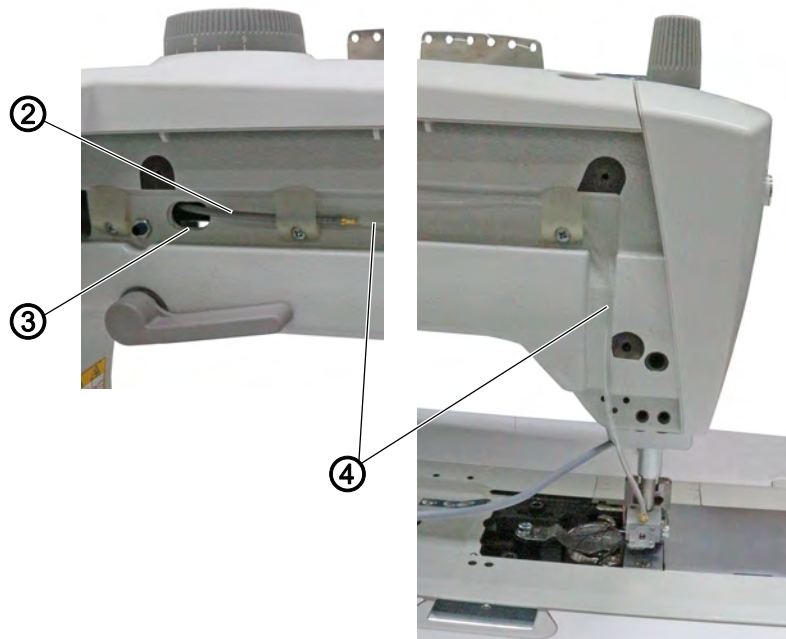

(2) - Hose
(3) - Slot

(4) - Hose



4. Connect hoses (2) and (4).
5. Lay hoses (2) and (4) in the machine arm using cable clamps.
6. Feed the hose (2) through the slot (3).

Fig. 9: Assembling the pneumatic seam middle guide (3)

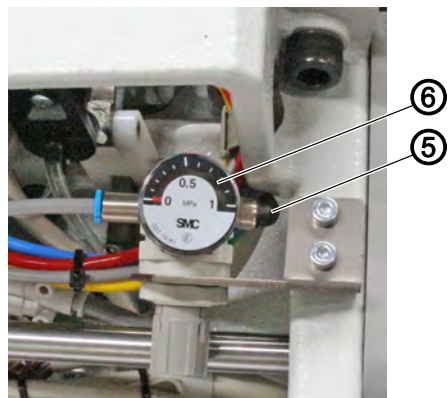
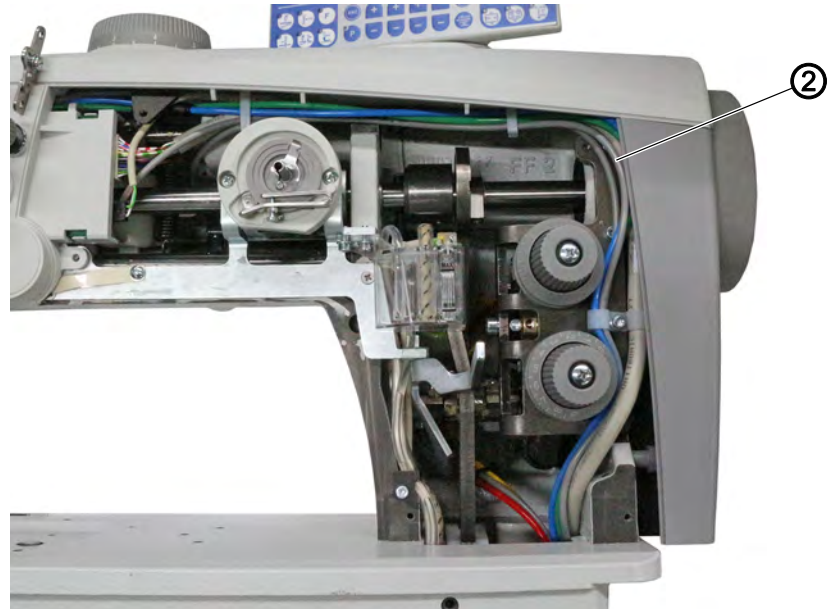

- (2) - Hose
(5) - Connection

- (6) - Compressed air maintenance unit



7. Lay the hose (2) through the machine arm.
8. Connect the hose (2) to the connection (5) of the compressed air maintenance unit (6).

Fig. 10: Assembling the pneumatic seam middle guide (4)

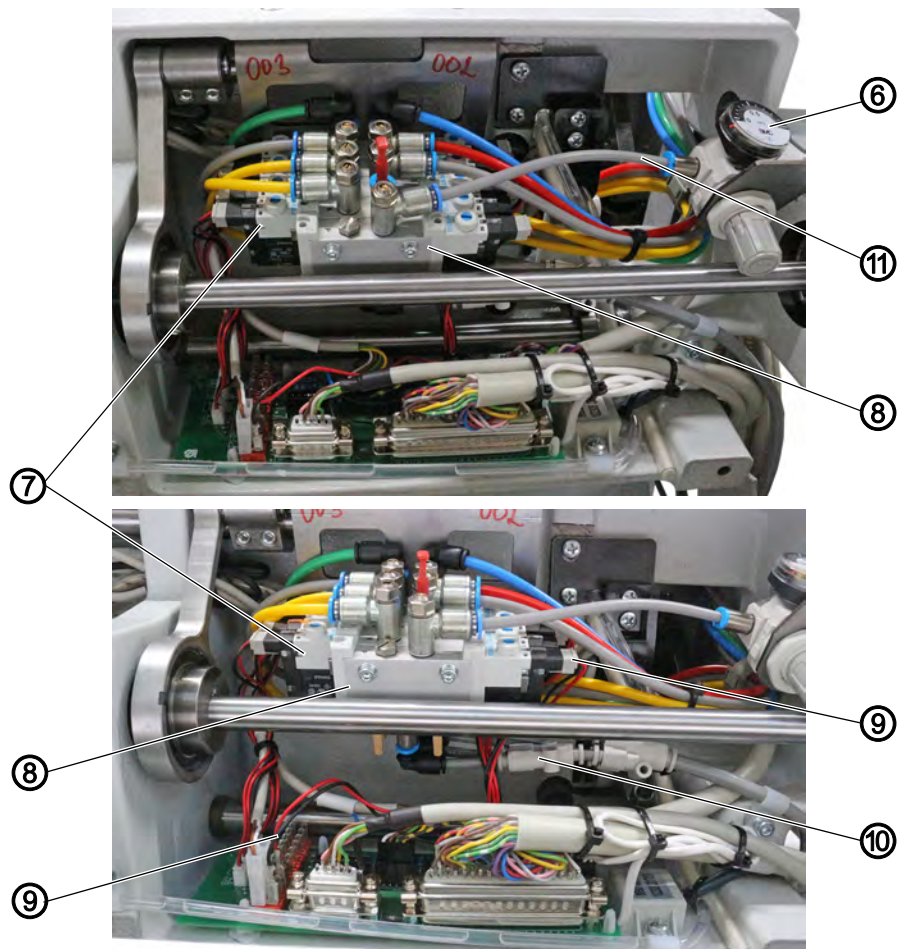

- | | |
|---------------------------------------|----------------|
| (6) - Compressed air maintenance unit | (9) - Cable |
| (7) - Pneumatic block | (10) - Y-piece |
| (8) - Pneumatic valve | (11) - Hose |



9. Screw the pneumatic valve (8) to the pneumatic block (7).
10. Connect the pneumatic valve (8) with the Y-piece (10) to the pneumatic block (7).
11. Connect the compressed air maintenance unit (6) with the hose (11) to the pneumatic valve (8).
12. Connect the cable (9) of the pneumatic valve (8) to the circuit board.
 - black: +
 - red: FF

Fig. 11: Assembling the pneumatic seam middle guide (5)

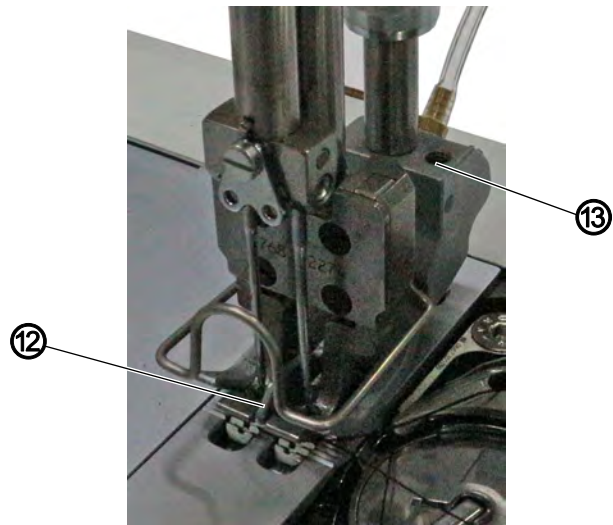

(12) - Seam middle guide

(13) - Screw



13. Set the spring pressure for the seam middle guide (12) using a screw (13).

↳ When the seam middle guide is switched off, it must also be lifted when lifting the sewing feet.

3 Setting the seam middle guide in the software

3.1 Assigning the *pneumatic seam middle guide* function to a free button

If a free button is available, the *pneumatic seam middle guide* function is assigned to it.





Fig. 12: Assigning the *pneumatic seam middle guide* function to a free button



(1) - Free button



To assign the *pneumatic seam middle guide* function to a free button:

1. Press the  button.
2. Press the free button (1).
 - ↳ The function is displayed.
3. Use the buttons + and - to set the function to 10.
4. Press the  button.
 - ↳ The parameter changes to *t 11 60*.
The function is 0 0.
5. Use the buttons + and - to set the function to 05.
6. Press the  button.
7. Open parameter *t 11 61*.
8. Set function to 1.
 - ↳ The seam middle guide is also lifted when lifting the sewing feet.
9. Apply sticker  to the free button (1).
10. Switch off and on the machine again.
 - ↳ The settings are saved.

3.2 Assigning *seam middle guide* function to the *Bartack* button

If the buttons are already assigned, the *seam middle guide* function is assigned to the *Bartack* button.

Since the *bartack* function is also assigned to the Favorites button, the *middle seam guide* function is also assigned to the original *Bartack* button.

The function can also be assigned to any other button.



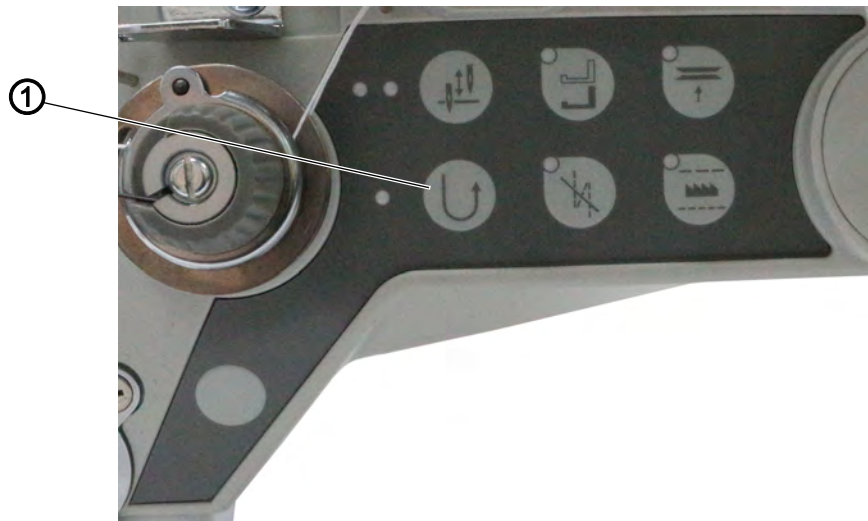

Fig. 13: Assigning *seam middle guide* function to the *Bartack* button



(1) - *Bartack* button



To assign the *pneumatic seam middle guide* function to a button:

1. Press the  button.
2. Press the *Bartack* button (1).
 - ↳ The function is displayed (0 3).
3. Use the buttons + and - to set the function to 10.
4. Press the  button.
 - ↳ The parameter changes to $t\ 11\ 60$.
The function is 0 0.
5. Use the buttons + and - to set the function to 05.
6. Press the  button.
7. Open parameter $t\ 11\ 61$.
8. Set function to 1.
 - ↳ The seam middle guide is also lifted when lifting the sewing feet.
9. Apply sticker  to the *Bartack* button (1).
10. Switch off and on the machine again.
 - ↳ The settings are saved.

Assigning *bartack* function to the Favorites button

Fig. 14: Assigning *bartack* function to the Favorites button



(1) - Favorite button



To assign the bartack function to the Favorites button:

1. The *bartack* function (reverse sewing) is assigned by the manufacturer to the Favorites button (1).

↪ Apply sticker  to the Favorites button (1).

4 Setting operating pressure of the pneumatic seam middle guide

Fig. 15: Setting operating pressure of the seam middle guide

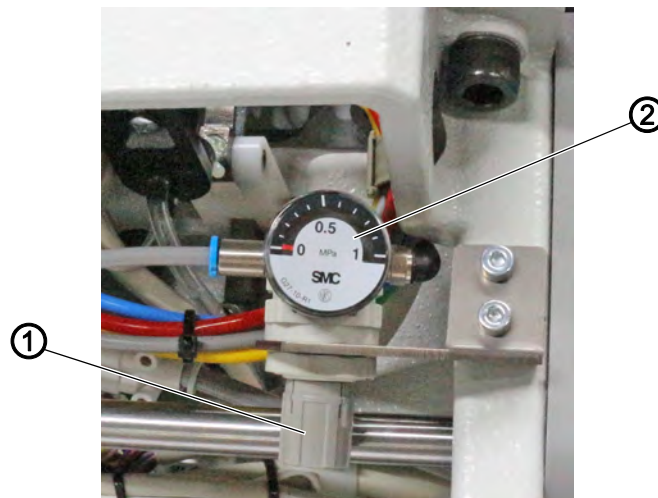

(1) - Pressure controller

(2) - Pressure gage



To set the operating pressure for the seam middle guide:

1. Set the pressure using the pressure controller (1).
 - Increase pressure: turn clockwise
 - Reduce pressure: turn counterclockwise
2. Set the pressure so that the manometer (2) displays the **value 0.5** (this corresponds to 5 bar).



DÜRKOPP ADLER AG
Potsdamer Str. 190
33719 Bielefeld
Germany
Phone: +49 (0) 521 925 00
Email: service@duerkopp-adler.com
www.duerkopp-adler.com